

BRANDED

BY THE SECURITY POLICE

The right of might - the source of inhumanity and state tyranny. The following is an account of the Swedish Security Police (SÄPO) and the use of humans for medical research, but it could equally well be from Nazi Germany, where state abuse was a natural part of the system. There are many similarities in the methods and routine use of brutality between the Gestapo and SÄPO. Moreover, SÄPO is exploiting a new kind of computer technique to enable them to control human thoughts and behaviour.



The above object is located in my skull. Directly anterior to the frontal bone, it was forcibly implanted at a hospital where I was awaiting an operation. SÄPO had forced the surgeon to participate in their scheme, preventing him from performing the original surgery. After violently sedating me, they make a 5 cm long incision in my frontal bone, in which they place the object: a radio-transmitter which has been transmitting a high-frequency electromagnetic beam through my brain 24 hours a day ever since. The actual dimensions of the device are a mere 7 x 4mm, the picture above being a detail of an X-ray, which can be seen in its entirety further on. The photograph has been digitally enhanced to remove shadows and the like so that the object can be seen in its true form. The reason for SÄPO's action was that I constituted a threat to the secret all state mindcontrol projects.

This covert operation of coupling people's brains to computers has been going on for decades, and it is not only SÄPO who is involved: transmitters are being implanted in people's heads during routine hospital surgery. Most commonly, these are inserted through the nostrils, from where they operate using two-way radio communication. After penetrating the brain, the radio-wave is processed in a system that hooks up the neurological functions to a computer. Afterwards, mental activity, biological processes, sensory function, in fact the entire life of the individual, are laid bare for state inspection and control.



The position of the transmitter

PHYSICAL CONTROL OF THE MIND

Toward a Psychonitized Society

JOSÉ M. R. DELGADO, M.D.



HARPER & ROW, PUBLISHERS
NEW YORK, EVANSTON, AND LONDON

In his report (see later), the eminent professor Petter Lindström calls the technique *Radio-hypnotic intracerebral control*. This says a lot about a science which is also known as *Bio-medical telemetry*, *mind control* or *Brain-computer interaction*. In the late 60s, the system, its potential and areas of application, were already being discussed by one of his colleagues, J.M. Delgado in his book *The Physical Control of the Mind*: "We are advancing rapidly in the pattern recognition of electronic correlates of behavior and in the methodology for two-way radio communication between brain and computers".

This has been going on for much longer than most people can imagine. It was, in fact, one of the first applications of computer technology, forty years ago, to link the human biological system with a computer. Thirty years ago, in 1968, Dr. Stuart Mackay published his *Bio-Medical Telemetry*, in which he outlined the potential of this latest science: "Among the many telemetry instruments being used today are miniature radio transmitters that can be swallowed or surgically implanted in man or animals....The scope of observation is to broad to more than hint at with few examples....They permits the simultaneous study of behavior or physiological functioning....In cases such as the monitoring of the welfare of a diver in the ocean or an astronaut in orbit, a continuous flow of physiologic information is essential."



The above X-ray photograph shows three implanted transmitters, of which one has been completely embedded in the frontal lobe. All of them were implanted on different occasions during the 1970s by the Swedish Criminal Police while I was under arrest in Stockholm and at the Nacka Police. By the time the X-ray was taken

P. A. LINDSTRÖM, M.D.
405 GALE STREET, CALIF.
12 JULIA STREET
1971-1972-1982

June 25, 1983

Mr. P. Maestlund

Dear Mr. Maestlund,

The enclosed letter of May 30 I had prepared in rough draft. I don't find a copy so I might not have mailed it to you. Later I received your additional skull film, which clearly demonstrated some implanted transmitters, one inside the brain and two probably just underneath the brain. Within a week I shall have that film examined by the radiologists here, but I do not expect them to prove, nor to rule out, any brain damage like granulomatous changes or a superficial brain abscess, at least not based on the findings of that plain skull film you sent.

I have been very busy the last months, which explains why I am uncertain about the mailing of the letter outlined May 30. I am serving as "Certified Consultant" in Neurosurgery and in Dentistry for the U.S. Department of Education. In addition I am very much engaged in teaching and surgical work as Clinical Professor in Neurosurgery at the University of California Hospital in San Diego and also as Senior Consultant at the local Veterans Medical Center. My schedule is as heavy as when I worked in Stockholm. There I was Associate Professor of Dentistry for six years and Consultant in Dentistry for the old Royal Medical Board of Sweden while I was studying medicine at the Karolinska Hospital. I have not done any studies or work in dentistry in this country.

Now you will understand why I cannot spend much time on your serious and complicated problems. Nevertheless, I might have seen

In this letter, one of many by Dr. Lindström, he writes that my cranial X-ray clearly exhibits a number of implanted transmitters, one of which is within my brain.

(1984). I had undergone two operations; the first transmitter that was implanted in me had been removed, as that one which had been inserted in my right nostril on my last detainment in police custody (1978).

A paper published at Yale University by an international team of six researchers in 1975 as part of a joint project between Yale University and the Medical University of Madrid entitled *Two-way communication with the brain*, describes how communication can be achieved with deep-brain processes using tiny transmitters, thereby also being able to suppress EEG patterns. They also state that because both energy and data is supplied by radio-waves, these transmitters last for life.

"Two-Way-Communication with the depth of the brain makes it possible to send and to receive information to and from the brain. The technique eliminates the need to restrain the experimental subject,

permitting free behavioral expression and social relations. Instrumentation, including the radio links, is small and light and does not interfere with mobility... Our experiment demonstrated the suppression of a specific EEG pattern by repeated feed-back radio stimulation of a specific intracerebral point ... As no batteries are used, the life of the instrument is indefinite. Power and information are supplied by radio frequencies"

It has been almost thirty years since the first transmitter was implanted in my head at Söder Hospital; the issue is in fact much bigger and even more shocking since surgeons have also been placing these transmitters in the heads of patients under anaesthetic on the operating table. This is what happened to me at the end of the 1960s when I underwent surgery at Söder Hospital.



The above photograph is of the surgeon, Dr. Curt Strand, who implanted the first transmitter in my head; and what is certain is that he was not working alone but on behalf of the hospital itself. At this point in time I had been a completely normal member of society. I had never committed a crime nor had any contact with psychiatry; I was in employment; in fact there was nothing about my life which could warrant the taking of special measures to observe me. The only reasonable conclusion is that Dr. Strand and his colleagues implant transmitters in the heads of their patients during operations on a regular basis. There is no reason

whatever to believe that I was an exception.

Thirty years ago, in 1965, a researcher at the Defence Research Institution department 3 for information technology, a P.M. Persson, published an article on biomedical telemetry in which he wrote:

"Telemetry, i.e. the radio-transmission of data, is applied primarily when it is difficult or impossible to supply the parameters by any other method...the word Telemetry is derived from the Greek tele meaning "far off" and meter meaning "to measure". In Swedish, telemetry would therefore be called "fjärrmätning" (long-distance measuring)...A significant part of bio-telemetry is conducted principally with the use of implanted transmitters, the development of which has come a long way in medical research."

What had actually been well developed in medical research was of course the abuse of patients in whose heads the surgeons were implanting transmitters.



At the time of the Söder Hospital abuse, 1967

For the years following the implantation of the transmitter at Söder Hospital, I was actually quite unaware that anything had happened. All I was mindful of was a weak radio signal of unidentifiable origin inside my head. It was only after a few years that I became wise to something having been put inside me during the operation. This time was to be a period of great and

inexplicable change, and when I turned thirty, I decided to tread a criminal path. It is perhaps hard to claim with any certainty that this was a result of what was happening to me, but it was in any case after the implantation of the transmitter which linked my brain to a computer scientists could use me for their own wicked designs that my conceptions and feelings were never to be the same again.

In the same year as Söder Hospital implanted the transmitter in my head (1967), the Department of Psychiatry at Yale University in the USA published a report entitled *Man's intervention in intracerebral functions*.

"...Techniques are being developed for the investigation and manipulation of man. Two way communication with the depth of the brain makes it possible to send and receive information to and from the brain... We can start, stop or modify a variety of autonomic, somatic, behavioral, and mental manifestations. We can experiment with intracerebral mechanisms responsible for the onset and maintenance of specific behavioral and mental functions... As no batteries are used, the life of the transmitter is indefinite. Power and information are supplied by radio-frequencies."

The report of a Parliamentary Committee chaired by Alva Myrdal, SOU 1972:59 *To choose the future*, addressed this technique:

"...Research into the field of cerebral function and behaviour has as its primary aim to identify the type and degree of changes that can be effected with these new methods, thereby providing

information on new possibilities for easing human suffering as well as the risks of control and modification of behaviour against the people's will."

The state report SOU 1987:74 also mentions the technique, discussing the ability to see through the eyes of another person:

"It is inevitable that covert personal surveillance brings with it a significant infringement of individual integrity. A person's private and public doings can be registered and documented to a high degree. This also includes any encounters the individual has with other people. Letters and other such written communication which the individual receives, for example, at home or in the office, can be monitored during surveillance."

It was on my first occasion with the police, on March 10th 1972, that I was put to sleep without my consent and when I awoke a few hours later it was to a whole new kind of life. The first thing I was aware of was a deeply disturbing radio signal in my head. The electromagnetic wave which was penetrating my skull was brain-washing, and had a detrimental effect on my memory functions, habits and behaviour. Slowly but surely I was being changed into a different person with greatly impaired faculties. As can be seen from the X-ray photograph printed below, this transmitter had been inserted through the left nostril. The experiment which then began went on daily, unchanging, for the following 3.5 years. It inhibited the capacity of my left cerebral hemisphere, and after a short while I lost such basic skills as sequentiality, making the alphabet, for example, a swarm of irretrievably disordered letters. My capacity for logical thought was impaired and due to the brain-washing, I had great mnemonic problems, which created daily chaos. Dr. Lindstrom's reference in his second letter (see later) to the process as the electronic dissolution of the memory, is a fitting description of what was happening to me.

Gordon Thomas, the well-known author and BBC producer, writes in the introduction to his book *Journey into Madness*, that:

"The book reveals how, since the 1950s, doctors in both east and west have ignored the sacred oaths of their profession and helped in governments-sponsored research into methods of medical torture and mind control."



Stockholm's custody centre. Here, I was put to sleep several times to have transmitters implanted in my head and even embedded in my brain.

to have an X-ray examination. There the radiologist was able to identify two foreign objects in the extension of the nasal passages, adjacent to the frontal lobe. On my return to Sweden, I handed over the X-rays to the Board of Health and Welfare to confirm my previous claims. They, in turn, passed them on for examination by their own radiological consultant, Dr. Kjell

Bergström of Uppsala's Academic hospital, who promise to produce a report.



The above is a detail of an X-ray showing the nasal passages and the area behind the forehead. The two shaded parts indicate the position of the transmitters that were surgically removed at private hospitals overseas. Number 1 was inserted at Söder Hospital, while Number 5 was the one I received in police custody in 1978. Number 2 shows the first transmitter that the police put in me on March 10th 1972, while Number 3 was implanted either at Stockholm's detention centre or in custody in Västerås in 1973. Number 4 was inserted on

November 26th 1975 at the Nacka Police custody centre, where I was also put under sedation.

Nine years went by before I tried to do something about the ever-increasing torment. Then, in 1976, I wrote to Bror Rexed, the general director of the Board of Health and Welfare, and explained what was happening to me and how it had all begun. What I failed to understand then, however, was that there were unwritten routines to bury as swiftly as possible any reports concerning the existence of these barbaric practices. Instead of answering my letter, he passed it on to the department responsible for psychiatric care, who contacted me with a warning that I could be taken in if I continued to make the claims I had made to Rexed.

"...The state, with the aid of psychiatrists, can effectively silence people who oppose its policies. state manipulation of psychiatry for political ends is a reality in many countries". "The Striking of Bodies and Minds", published by The American Association for the Advancement of Science

On a trip to Athens in the summer of 1977, I took the opportunity



Dr. Kjell Bergström

When after a time I still had received no reply, I made several attempts to contact Dr. Bergström, but every time he proved elusive until it became quite clear that he was not prepared to make a report at all. After a lot of correspondence both by letter and phone, he finally submitted and made his reply - six months late. It came as no surprise that his report was entirely misleading. He denied the existence of any foreign objects in my head and claimed that my cranial X-rays were perfectly normal.

I was forced then to do something about my enslaved life. I travelled back to Athens in February 1978 and met the radiologist who helped

me come into contact with a surgeon who was prepared to operate.

The transmitter that had been implanted in my head at Söder Hospital was finally removed on March 13th 1978 after having been in operation for 11 long years. A month separated Dr. Bergström's report that my X-rays were all in order and the operation.

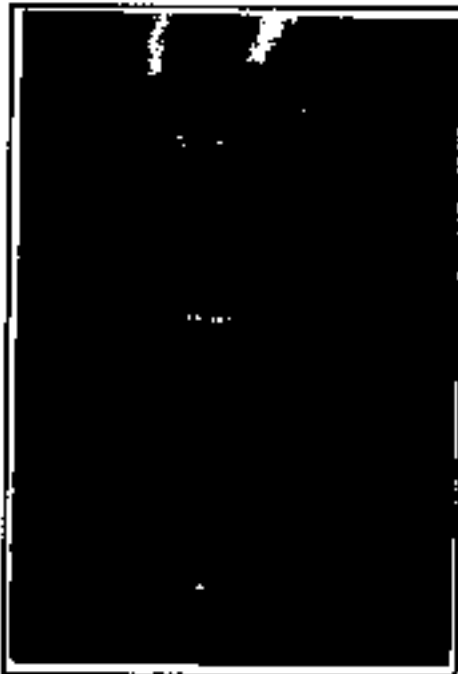

The above photograph shows the opened frontal bone in which a foreign object can be clearly seen lying completely free from the rest of the cranium. The doctor trepanned an area adjacent to the right nasal root on a level with the eyebrow. My life improved measurably after the removal of the then four transmitters which had been transmitting electromagnetic waves through my brain.

Dr. Gregorius promised to perform the next operation a couple of months later, but the week before I was due to return to Athens I was arrested by the police for a crime that had been committed some months earlier. After a few days in custody, Dr. Annmari Jonsson from the Board of Health and Welfare comes in for a chat. This is in July 1978.

She is the psychiatrist who had contacted me the previous year in connection with my correspondence with Rexed. It was she who threatened me with psychiatric confinement if I persisted in making

claims about a transmitter having been implanted in my head at Söder Hospital. She was now getting serious and was prepared to use her position to silence me in a criminal collusion with the doctors and the police.

The talk lasted no longer than a few minutes, after which she was ready to prepare the report which was to pave the way for the coming psychiatric diagnosis which the Board of Health and Welfare could then, following the routine, use as a weapon for concealing the illegal activity of the state. Her report was based on the obvious fact that anyone who claims that they are being used for scientific research into telemetry is mentally ill, especially me, who was also threatening to expose something of an extremely classified nature. This was justification enough to brand me as a chronically paranoid individual. Annmari Jonsson report of August 1978 included the following:



Dr Annmari Jonsson

"He fiercely maintains everything that he wrote to the General Director. He becomes indignant and clearly offended if anyone questions the reality of his medical history. In doing so, he displays clear delusions and and is also paranoid. He is psychotic, in need of hospitalisation and there is every reason for forensic-psychiatric examination."

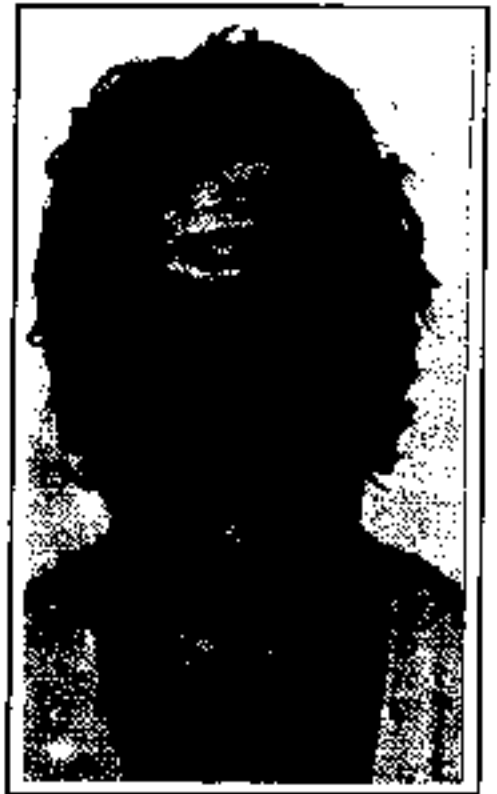

May 1978, after the operation in Athens and two months before Dr. Jonsson's report.

This is me at 37. I have never had any psychiatric problems, never had any contact with mental care or displayed any inhuman traits or used violence. The reason why it was so important for the psychiatrists to diagnose me as mentally ill, was that the use of brain-computer systems involves the infringement of the basic human right to life and that anyone who constitutes a threat to this secret shall be silenced at any price; it is also important for them to create the illusion that those who claim that they are being subjected to such abuse have mental problems.

"Surgical implants have been used in rather intricate ways; in some cases, animals are born with functioning transmitters already in them."

Extract from "Engineering in Medicine and Biology Magazine" March 1983 by Dean C. Jester Ph.D. and assistant Professor, Biomedical Engineering at the Marquette University Milwaukee Wisconsin



This is Dr. Janes Jez, the psychiatrist who conducted my forensic-psychiatric examination and who is ultimately responsible for the psychiatric diagnosis. In his report, he wrote that *"Robert Naeslund ought to be considered dangerous if his system of delusions can not be cured and he starts to doubt his conceptions and obtain insight into his illness."*

I was, of course, dangerous to nobody other than the state criminals who collaborated in the abuse, like Dr. Curt Strand, Dr. Annari Jansson or Dr. Janes Jez himself. When I was able to otherwise obtain the verification of Dr Lindström and several other doctors some years later, I submitted a letter containing the correct X-ray reports to both the Board of Health and Welfare and the above named doctors for comment. But they reacted just like criminals. They will do anything to bury the truth when they are finally exposed and so they refuse to answer my letters and to admit that they had even received them, despite the fact that I have sent letters on a number of occasions a couple of years apart. There is of course nothing that they can add. It has been proved beyond a shadow of doubt that they have used psychiatry as a weapon against me to conceal the brutality of the state in its implantation of transmitters in my head and my subsequent exploitation in a continual, perpetual scientific experiment.

Some years ago, there was a media scare concerning the use of psychiatric incarceration in the Soviet Union as a political weapon against dissidents. The situation is

not so different in Sweden, as my case shows. I was simply trying to free myself from the experiment from which I had suffered for the previous 11 years and to retrieve the human rights I was entitled to, the right not to be enslaved by institutional experiments and research.

"The process of miniaturisation has already passed the stage of the injectable transponder, a tiny ampoule capable of storing data and acting as a sender and a receiver."

Jan Freese, in *"The Despondent Incompetence"*



This is Dr. Tord Svahn of Huddinge Hospital, and one of those who Dr. Jez involved in the plot against me to legitimise his diagnosis. The background was that, during the forensic psychiatric examination, I demanded that a radiological study be made of my skull, since I then knew that these objects would show up on the X-rays. But Dr. Jez denied me this, and I had to fight for three months before he gave in. The radiological examination was conducted by Dr. Svahn, who also undersigned the reports confirming their normal status. It was only after a couple of years that I was able to expose Dr. Svahn's deliberately fallacious report for what it was, thanks to the X-rays being requisitioned from Huddinge by a doctor which led to their further study by other medical practitioners. All the doctors who saw the pictures have been able to identify the implanted foreign objects, something which they have also confirmed in reports.



The above is one of many X-rays taken at Huddinge Hospital during the forensic psychiatric examination, and is also one of a number of pictures which shows the implanted transmitters. But this was of course something which Dr. Svahn failed to mention. If he had done so, Dr. Jez would not have been able to diagnose me as mentally ill.

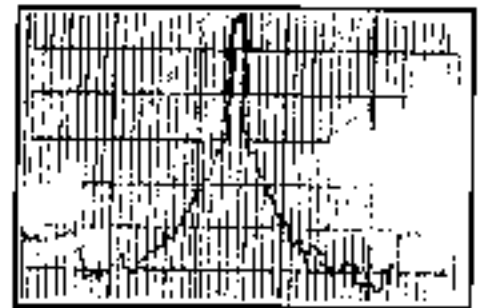

With the help of several electronics companies in Stockholm which supplied me with both the means and the know-how, I was also able to ascertain the frequencies of the electromagnetic waves which were travelling through my head to these transmitters. The illustration above, created using a printer hooked up to a spectral analyser, shows one of these wavelengths. The frequency at 18.5 kHz lies within the long wave part of the spectrum and is called a frequency-shift signal, which means that it moves within a certain frequency range. All the frequencies as entered my head, that we detected, lay within the same part of the spectrum, between 17 and 24 kHz.

"Implantable instruments installed during surgery offer a singular opportunity for advances in medical research and practice for two distinct reasons." From a research report (1984) by the US researcher James D. Moody

About 20 years ago (1976), researchers Eskil Block and Per Scharestrom published their *Man and Technology in the Society of the Future*. The book addresses this technique: "...The study of electro-ionic communication has given us a much greater opportunity to understand vital aspects of the human nervous system and sensory organs. Out of this technology then grew a more abstract and general science, cybernetics, the study of communication and control... advancements in science and technology show us again and again that we must be prepared to adjust our view of the world and reassess the limits of what is possible."

This is the letter in which Dr. Lindstrom describes the technique of using transmitters as radio-hypnotic intracerebral control and the electronic dissolution of the memory.

 UNIVERSITY HOSPITAL
University of California
San Diego, San Diego

TO WHOM IT MAY CONCERN:

Recently I reviewed a skull film marked: HASLUND, ROBERT and dated 26-11, 1981. That film shows a couple of unusual foreign bodies at the base of the skull, possibly some form of brain transmitters.

However, I have not examined or talked to this patient and do not know the pertinent history.

San Diego, CA
October 6, 1983

Ingemar Wickström

Ingemar Wickström, M.D.
Professor of Radiology
U.C.S.D.

connected with the implanted objects.

When the state commits a serious crime, it is ensured that none of their own will reveal the secret. In that case all would be lost from the start. For that reason among others,

the radiologists at the different hospitals deny the existence of foreign objects in my head, as we can see from the reports of Drs. Bergström and Svahn. There are, however, many other radiologists who use their position to deny the truth in one huge collective fabrication, so that nothing about the abuses threatens to leak out. It was therefore critical when Dr. Lindström produced an entirely contradictory report concerning the X-rays that the Swedish doctors had declared normal. It was therefore also in the nature of things that the Swedish doctors tried to make Dr. Lindström retract his report. Doctors at both Karolinska

Hospital and the Karolinska Institute who actually had absolutely nothing to do with my case, wrote to Dr. Lindström insisting that he conduct himself properly and not make that kind of report. Would it be possible

for him to reconsider his statements? Others took a tougher line, saying he was not competent to examine X-rays and that he ought to change his mind. There was not a single person acting out of any other motive than that of concealing his own or his colleagues' malpractice; the psychiatric clinic at Karolinska Hospital is another example. Failing to find out the facts, an easy enough task considering that Dr. Lindström's name and address are on the letters, they contacted the Board of Health and Welfare with

the incredible story that the reports I had submitted were my own fabrications!

Instead of making him toe their line, the Swedish doctors' behaviour had the opposite effect. He felt quite naturally indignant that they had tried to force him to conform to the corrupt Swedish model, and as a result he passed on certain of my X-rays to some of his colleagues at the University, asking them to write down exactly what they could see without first giving them any prior information. Professor Wickström produced one such report. He had previously been chief clinician of the radiological department at Sahlgrenska Hospital, Gothenburg, Sweden.

P. A. LINDSTRÖM, M.D.
MEDICAL DIRECTOR
OF RADIOLOGY
U.C.S.D.

July 27, 1983

Mr. Robert Haslund

Dear Mr. Haslund

In response to your most recent letter regarding the roentgen films I can only confirm that some foreign objects, most likely brain transmitters have been implanted at the base of your frontal brain and in the skull.

The risk of such implantations is considerable and the risk of chronic infections and meningitis when the implantation has been made through the nose or the sinuses are real issues.

In my opinion, there is no excuse for such implantations if the patient has not been fully informed about the procedure, the purposes, the risks, the method of anesthesia, etc. and has given a clear written consent.

I fully agree with Lincoln Lawrence, who in his book on page 27 wrote: "There are two particularly dreadful procedures which have been developed. These working and playing with them secretly call them R.H.I.C. and C.T.D.M. -- Radio-Hypnotic Intracerebral Control and Electronic Dissolution of Memory."

Many years ago I had some discussions with Dr. Gede. He asked me to apply my ultrasonic technique for his particular purpose of altering patient's behavior but I declined because we had entirely different aims and approaches. However, I found Gede to be an intelligent but somewhat strange man.

Best wishes!

P. A. Lindström

P. A. Lindström, M.D.
Professor

He also writes that there is a risk of meningitis and chronic infections with such implantations. I have in fact had constant sinus infection since the beginning of the 1970s, something which is most probably

CYBERGUDAR

RECEIVED FROM

DR FRANKENSTEIN

DATAINJEKTION

CHIPS

RADIOIMPLANTAT

HJARNKONTROLL

DATAKANNIBALER



The contradictory reports of the Swedish doctors and their overseas colleagues gives a clear picture of

That data from the nervous system continues to flow into the computers at an increasing rate is due to the fact that more and more people are being hooked up to the system. The growing rate of hospital, SÄPO and Criminal Police abuse is built upon

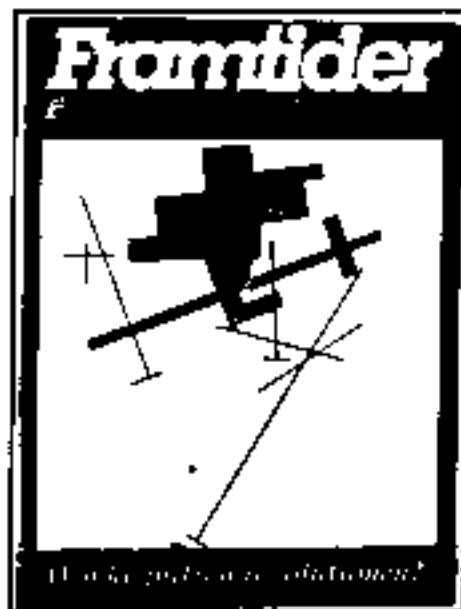

the mind-control system which has been highly developed within medical research, as the Defence Research Institution researcher P.M.Persson wrote back in 1965. The only reason for my being diagnosed as mentally ill was that this is something which we are not supposed to know, an operation which the scientists and the police want no interference with.

To give an idea of the kind of experiments I was being subjected to, consider the following aspect of these systems: during the years 1979-1984, I suffered from their power to generate disease in a person. This is something that has been well recorded by medical researchers. In *Bio-Medical Telemetry*, (1968) Dr. Mackay wrote that: "There are certainly more elaborate and immediate methods for accelerating human and animal subjects into a state of motion sickness."

His chilling claims that immediate and accelerating morbid states can be induced through two-way radio communication with the brain, also reveals his own attitudes concerning the possible areas of application for these methods. And that was exactly what I was forced to for those six years between 1979-1984.

From back in 1972, when the police implanted their first transmitter in me, the predominant effect were powerful radio signals in my head, with which I was made to live for 13 years. These signals continuously intensified, and oscillated during the years between loud bass notes and piercing high-frequency signals, with the entire intervening sound spectrum at varying volumes. This changed my life and altered my moods; it often induced insomnia, an inability to concentrate, irritation, impaired thinking and lowered spirits to say the least. But there were also changes to my behaviour, which sometimes meant that I ended up unusually out of my depth, or did things completely out of my character. The symptoms which the scientists had begun to induce at the time of my residence at Sidsjön's special psychiatric clinic in 1978-79, were exact reproductions of earlier illnesses, like the throat infections which kept me in a recurring state of cold and fever for nigh on 50% of those six years. When a period of illness passed, another throat infection was caused at exactly the same spot, and all started again.

The Breaking of Bodies and Minds

Torture,
Psychiatric Abuse,
and the
Health Professions

Edited by Eric Slosser and Elena O. Nighingale, M.D.
America's Association for the Advancement of Science

This is the technique with which it is possible to control all cerebral functions and biological processes. During the first three years of the 1980s, my brain's thermoregulator was made to malfunction, producing temperature swings between extreme heat and cold for several hours practically. Between 1981-83, I had to accept controlling my heart with such precision that they could bring it almost to a stop; this also went on

for hours at a time, at least every night, after which they hyper-activated it. The pattern was so systematic that it must have been produced by a computer programme. From August 1978, when I was put to sleep in custody for the last time, and from when the transmitter that was inserted into my right nostril began its four-year operation, I suffered from cramp in my legs, feet, hands and arms for hours every day until the transmitter was finally removed in Athens 1982. This is just an example of the kind of pathogenic experiments I was subjected to from 1978 to 1984.



The above photograph, taken in 1979, shows the tremendous changes that took place as a result of the experiment becoming much tougher. Compare it to the photograph on page 5, taken a year earlier.

It was only after Dr. Lindström et al made accurate statements concerning the contents of my X-rays that the brain experiment, which had intensified continuously since 1972, levelled off. When the electronics companies gave me the opportunity to demonstrate the different frequencies of the waves that were passing through my head, the effect lessened and after the Red Cross in Stockholm had spoken to Dr. Lindström in the USA to discuss possible surgery in the USA, intending to assist me with the necessary travel costs, the terror, from which I had suffered for twelve years, stopped altogether. The operation came to nothing, however, as for the first time ever I was refused an entry visa into the States.



1980. At this point in time, I have some serious interference inside my skull resembling the high-pitched whining of a drill, a noise which is being transmitted by radio-wave. I never sleep for more than a couple of hours a day, and this continues right up to 1984.

This picture shows the effects of the induced illnesses, insomnia and enfeebled brain. Notice how the left eyebrow has sunk way below the right. This is a result of my impaired right cerebral hemisphere, which controls the opposite side of the body. From November 1975, when the Nacka police put me under sedation and embedded a transmitter into that part of my brain, the experiment was dominated by an reduction in the properties associated with the lobes on that side. Notice also that my hair at this time is completely lifeless.



December 1984. About 6 months after the torture terminated.

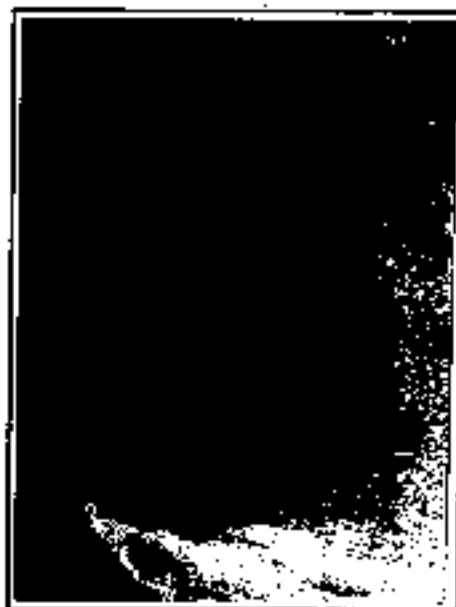

This photograph shows the original X-ray and the mushroom-shaped transmitter which we saw on page one. Here it appears in its actual size, lying in what looks like a crater. This is in fact the wound the SAPO made in my head when they opened my frontal bone and implanted the object. In a written report, a Stockholm hospital estimates the size of the area to be 0.5cm deep and 2cm in diameter.

The events preceding the assault took place in 1987 at St. Carolus' Hospital in Djakarta, Indonesia, where I was awaiting an operation to remove the transmitters that had already been implanted. It began as I was being wheeled into the operating theatre. Standing outside is the surgeon, a professor of neurosurgery called Hendayo. He informs me that he is unable to go through with the operation which had been scheduled for this day since a week previously. He tells me that we have to postpone it, explaining that he cannot reveal details about why the operation cannot be performed now. I try nevertheless to persuade him to keep to his side of the agreement, and after a short discussion, he changes his mind and I am wheeled into the operating room. What is known to him, and what he does not tell me but what I realise the moment I enter the room, is that there are two plain-clothed men waiting for me. They grab me by the arms, and before I can protest, they inject me with something and I lose consciousness.

When trying to free yourself from Frankensteinian techniques, it is surely a necessity to experience frightening things. When I come round, it is right in the middle of the operation and I can feel a sharp pain in my head. My arms and legs have been strapped down and the doctor is holding my head while one of the two plain-clothed men, wielding an object similar to a branding iron once used to mark animals. The instrument has also been heated and he pushes it down into my opened head. It feels as if my skull is going to explode, and I scream in agony before I lose consciousness once more. 18 hours pass before I wake up. The first thing I do then is to go directly to the X-ray department and report what happened. They take the X-ray which is reproduced here.



Outside St. Carolus Hospital

The radiologist thought that it looked like a burn into which some sort of foreign object had been placed. Afterwards, I went to the head of the hospital to tell him what has taken place and I am informed that Dr. Hendayo is not due back for a couple of days. When I later make contact with him, he explains that what happened was not of his doing.

That I should have understood when he backed out and that he had been unable to act because my country's security police were involved. The presence of both the burn and the implanted object has been confirmed by a number of radiological reports.

A hospital in Stockholm writes that:
 "... To the left in the
 margosuprabortalis is a deep
 groove, 2 cm in diameter and 0,5
 cm in depth."

According to a hospital overseas:
 "X-ray skull lateral view shows a
 radioluscent defect just behind the
 frontal sinus. An umbrella-shaped
 foreign body is seen in relation to
 the defect just above the right orbital
 roof."



August 1987. The day following
 SAPO's abuse.

These events at St.Carolus' Hospital in Djakarta in August 1987, reveal another side to the difficulties experienced when attempting to free oneself from mind-control, in which the state registers both ones thoughts and actions on their computers. Professor Hendayo realised that he could not operate on me nor do anything about the situation when the security police - possibly along with their colleagues in the CIA - forbade him from operating on me and took over the surgical department of St.Carolus' Hospital where they later branded me and implanted another transmitter in my head. The mushroom-shaped transmitter lies adjacent to the right frontal lobe, which it paralyses. Once again, like during the first half of the 1980s, one of the effects of the transmitter reappears in the left side of my body. It is particularly noticeable in the face where the left eyebrow now droops as a sign of cerebral impairment. The radiation has an effect different than that produced by the other transmitters, as it operates with high-frequency

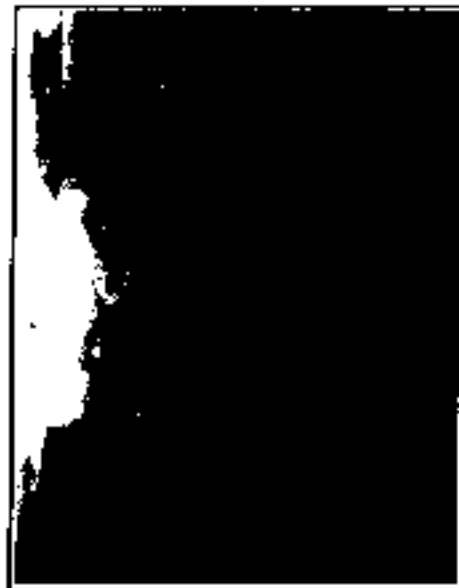

The above photograph was taken following SAPO's abuse and shows how they are keeping me in a state between sleep and wakefulness in order to pacify me. The left side of my face is clearly collapsing due to the debilitation of the right cerebral hemisphere.

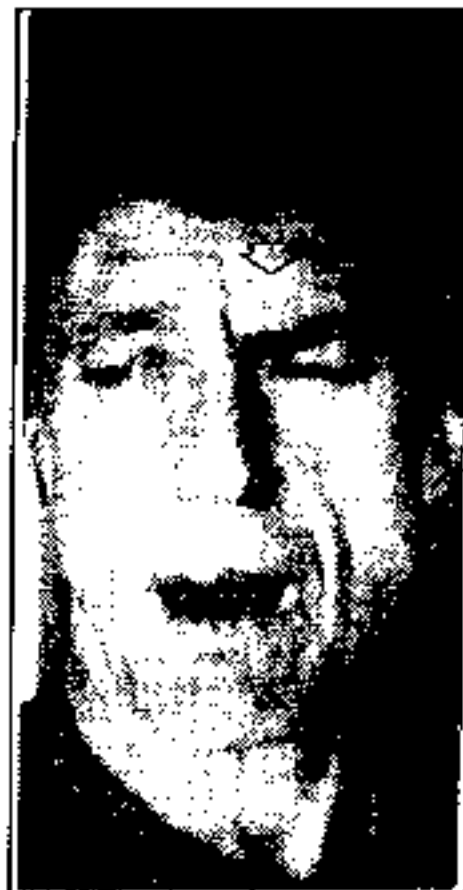

1994 - the torture is visibly continuing. The right hemisphere has been debilitated with the effect on the face. Notice how deeply on this occasion the left eyebrow is sagging (see arrow)

radio-waves lying just before the micro-wave part of the spectrum. Right from the start I can feel how the temperature of my brain rises, the consequences of which change my life and influence my abilities, my energy and alertness. This radiation is also dangerous and known to induce cancer and leukaemia. As a completely normal symptom of a paralysed right hemisphere, I have lost all emotions including my sexual feelings.



These are my eyes which the radio-wave dehydrates, causes constant infection and visual defects. There are medical certificates 1-2 years apart which confirm the continual and untreatable infections. They also testify to the greatly impaired vision and that the eyes are astigmatic. I myself can affirm that the continual deterioration of my vision has led to my needing both glasses and a magnifying glass when reading normal letters and that the sharp smarting in my eyes produced by the dehydration, together with the infections and my impaired ability to see, constitute a excruciating part of SAPO's assault.

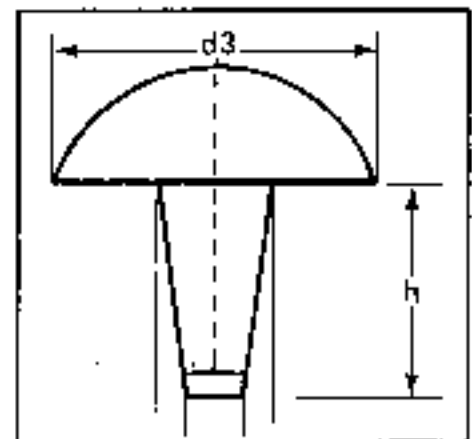

"Drawing of an epidural peg electrode. The electrode is composed of medical grade silicone with a stainless steel or platinum electrode at the base of the stalk."

The above illustration and the accompanying text comes from the medical company, Dow-Corning's

advertisement for their new electrode for implantation into people's heads. It was published in *Neurology and Biomedical Engineering* (1990) which also mentions a: "...New electrode design for the extradural recording of brain activity... Epidural peg electrodes are implantable mushroom-shaped composites of Silastic elastomer... Recording cerebral activity from the extradural space is not a new concept... Extradural strip electrodes have a low risk of infection, are well tolerated by patients, and have excellent recording characteristics."

Like all such radio-devices, it transmits data from a person's inner life, his mental functions, biological and neurological processes, all of which can be combined to yield more information about someone's life than that the person himself is knowing about his own life. They can be used to brain-wash, to manipulate inner processes, modify or destroy emotions, thoughts or deeds, and, as one of the earlier research papers said, *control behaviour in detail*. It is the most fantastic - and the most frightening - technique that has ever been developed, and consequently one of the biggest secrets ever to be held by the state. The new transmitter was to brainwash me to a much greater extent than any of the previous ones, by which I mean that they reduced my memory, making it more difficult for me to make any progress with this, which was probably what SAPO intended. What is clear throughout all the events is how doctors, psychiatrists and SAPO are prepared to go far to prevent any leaks from revealing the secret of the technique, the brutal experiments and the abuse of people in life-long research projects. It is easy to understand that this must be SAPO's primary weapon and the fact that they, as well as the Criminal Police, are using the technique and anaesthetising people under arrest to implant transmitters in their heads and brains will without doubt paint a whole new picture about what these authorities actually represent. Obviously, the state will do anything to prevent leaks concerning these developments - and it is not difficult to see that the technique can only be employed as long as the public know nothing about it.

Having been used as an experimental subject for different state projects for about 30 years has meant that I have had to live my life without the normal freedoms and personal security necessary to plan and choose your own destiny. One can say that I have to live like a modern slave, the agony taking on a greater right to my life than that which I myself can claim to. I have never been able to escape the continual experiment in my brain and have had to bear complete observation by medical/police research and their intrusion into my life as an invisible party to everything I do. My life has been deprived of human rights and integrity and I have been stripped, studied, exploited, raped and threatened with my life. Not so much in words as in the circumstances with which I have had to bear. For me, I need to find a doctor - with the assistance of the media or of politicians - who is able to operate, first and foremost to remove SAPO's transmitter in the face of SAPO's power. The high-frequency radiation is destroying my health and I am living with the constant threat of lethal injury.



This is Mats Börjesson, ex head of SAPO, and the man responsible for the violation of 1987. It is these kind of people and the way they act that is the dangerous face of nazism in our society. They are backed up by the entire political system, and there is no court in the country who will convict a Mats Börjesson when he or someone acting on his orders wreck lives, cause the suffering of

innocent people through their violence or open their heads to implant radiation objects. There is no psychiatrist about to lose his job or honour by using, like Drs. Annmari Jonsson and Janes Jez, psychiatric certification as a political tool for concealing their own, their colleagues' and society's crimes. Nor is there any surgeon answerable for the implantation of radio-transmitters in the heads and brains of patients while they are under anaesthetic prior to surgery; and it is the same story with radiologists who produce false reports to protect state institutional abuses as well.

In February this year (1996), the newspapers carried the sensational information that the ex head of the Mexican security police, Enrique Arenal Alonso, had been arrested on suspicion of using torture during cross-examinations in 1994. If we in Sweden wish to live in a society where the authorities have to take responsibility for their actions, it follows that Mats Börjesson must also be arrested. This might be necessary for finding out what is actually happening behind SAPO's high walls of secrecy, and how far the abuse of people with the implantation of transmitters has gone. Mats Börjesson is responsible for the events of August 1987 at St. Carolus' Hospital, and thereby for the kind of life I have had to suffer and the torture I have had to endure for the last 9 years.

Essentially every time I was arrested, during the years of my criminal activity (1972-78), I was anaesthetised without my consent and had transmitters implanted in my head and in my frontal brain. The transmission of powerfully destructive radio signals in my head began already immediately after the insertion of the first transmitter in me by the Criminal Police in 1972, and was to continue, at an ever increasing rate, until 1984. The suffering, and its consequences, the sleeplessness and intellectual impairment etc., together with the neurological experiments, the brain-washing and the altered cerebral functions, changed my personality and behaviour beyond recognition so that I would do things completely out of my normal behaviour. As verified by the extracts from the

medical reports, with this technique, one can scrutinise a person, effectively right down to the very essence of what he is. As Dr. Mackay writes, the purpose of bio-telemetry is ostensibly to follow animals and people in their everyday lives. I became aware at a very early stage that they were able to register my thoughts, vision, emotions etc. The police never made use of the technique to arrest me or prevent me from acting unlawfully, despite knowing my plans in advance. Instead they stimulated my criminal behaviour and since I knew that they knew what I was doing, they were clearly safeguarding my criminal activity. The question is whether all this has also happened to other people in custody. There was nothing about me which would justify any special measures, after all.

Everyone at some time in their lives needs to go to hospital for an operation, but who would want to do it when it could mean becoming part of a medical research programme which can proceed for the

remainder of their lives? Dr. Lindström called the technique "radio-hypnotic intracerebral control" - who is prepared to sacrifice their lives to that? It can no longer be granted that he who lives his own life also has rights over it. This technique and its exploitation have completely transformed the accessibility to freedom and human rights. There is a group which has opened an investigation into all this. They have compiled a huge amount of material, including medical reports, articles, debates, books, governmental inquests etc. concerning the technique and its abuse, the research, the experiments, the resources and future projects. Those of you in the media or in politics who want to help me find a surgeon who value humanity more than SÄPO's yoke and authority can reach me at the Gruppen's address or on their fax. This is a very special subject and, apart from having 29 years experience of it, I have a great deal of knowledge which might be of interest to a wider public and I am also offering to give lectures and

take part in radio and television programmes, or anything else which is suggested.

This letter have been sent to the Justice Minister, Laila Freivalds, with an appeal that she has to stop SÄPO's terrorism against me and arrange for the operation. It has also been translated into Arabic so that the Arabic governments, the media, banks and financial institutions have the ability to take their own measures to protest against these inhuman developments and the torture that the Swedish authorities are using. This letter, in its three languages, will soon also on Internet.

Stockholm in October 1996.

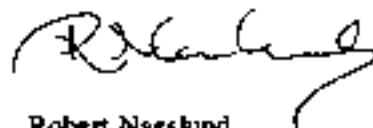

Robert Naeshund
Gruppen
Box 136
114 79 STOCKHOLM
Fax 08-668 60 66

The article has been distributed to several representatives of the state to give them a voice. To give them the opportunity to show their views and expose what the state stands for. The response they make will not only include their assessment of my own case but will be a much more general and fundamental opinion. We will also come to understand some of the intentions and the extent of these mind control systems. One of Sweden's leading psychiatrists, Professor Lars Lidberg, tells us how it is common for criminals to have frontal lobe injury, impairing their ability to understand the consequences of their actions. When the police made their psychiatric examination of Tommy Zethren, the Stureplan murderer, it transpired that he too had frontal lobe damage. My x-rays, which display three embedded transmitters in the frontal lobe, can also give an idea of how such damage has affected so many criminals.

On August 27th, 1996, I sent the article to the Parliamentary Commissioner for the Judiciary and Civil Administration together with a letter in which I posed the question as to whether my

experiences formed part of a legal state project and thus warranted no action on



Claes Eklund, Chief Commissioner for the Judiciary and Civil Administration, provided the answer

behalf of the Commissioner, or whether one could see the abuse as incompatible with the democratic society in which we live.

To understand the implications of his answer, it is necessary to be familiar with the authority he enjoys as laid out in

the constitution and in the Act of Parliament. These bestow supervisory powers for the Parliamentary Commissioner over people working for the public sector and demand that laws and statutes are obeyed.

His answer is simple to understand, short and concise. It goes as follows:

"You have filed a complaint against the Security Police and other bodies. The contents of your charges do not warrant any action or comment on my part. I am therefore not going to investigate the charges you have made." In other words, those who implanted transmitters in my head and brain without my consent and against my will have not in fact done anything wrong. Consequently I have no cause for complaint concerning that which I am, and have been subjected to

To learn the standards of medical ethics concerning implanting transmitters in people without their consent, the article was presented to Sweden's Professor of Medical Ethics, Göran Henteren of Lund



Professor Göran Hermelin

University, along with a separate letter, on September 30th 1996. The letter contained a request for assistance of a surgeon who will operate on me. In the letter, it was mentioned that "In your book, "Kunskapens Pris" you write that no one may be subjected to physical or psychological injury, violation or humiliation as a result of the research, and you develop hypotheses concerning when a person in danger should be helped. I hope I fall within your criteria. My life is under serious threat; three transmitters have been implanted in my brain, causing frontal lobe damage...". I closed the letter with: "I thank you in anticipation of your help or of any suggestions you may have as to how I may escape the situation I am currently in"

The article was submitted to the Minister of Justice, Laila Freivalds, in order to give the Government an opportunity to express their standpoint on such issues. Have they legalised, behind the walls of power, the brutal abuse of individuals who have been put under sedation. Is it the Government's intention that I am to be held in a state of slavery for medical research and behaviour manipulation? Has Sweden left all the human rights conventions it has signed and held up as a symbol of democratic and justice? These are some of the questions that the Minister of Justice, Laila Freivalds, will reply to

In the enclosed letter I mentioned the object outlined in the "The enclosed article "Branded by the Security police" has been a literary theme for hundreds of years. It has been a nightmare in utopian horror-stories of a future world where man is subordinate to computer, and as sci-fi visions of a theme when the technology of human brain-mind control has been

realised. I have had meetings with many doctors on different countries, and all of them have been able to confirm what I have been subjected to after studying my x-rays. Backed up by the human rights conventions signed by Sweden. I would like to argue that there is no room for state institutions to claim any authorisation for the implantation of transmitters in people's heads and brains. No government can legislate a



Minister of Justice, Laila Freivalds.

rights to rule over its citizens brains and give itself power to destroy arbitrarily and individuals brain by implanting radio-transmitters in the brain, causing damage to the frontal lobes, as clearly happened in my case. It is hard to imagine a more serious crime which also expresses a totally inhuman interpretation of human rights and value...I also would like you to order SÄPO to cease their long-term terror against me." Or is it the Government's intention that I am going to be held in a state of slavery for medical and police abuse. These are some of the questions that the Minister of Justice, Laila Freivalds, will reply to.